



COOLINGFAN

80 38 mm

Axial Fan 增压型风扇



常用规格 (General Specification:)

- ◆外框 (Frame) : PBT OF UL 94V-0
- ◆扇叶 (Impeller) : PBT OF UL 94V-0
- ◆轴承型号 (Bearing Type) : Sleeve Bearing & Ball Bearing
- ◆引线 (Lead Wires) : UL Type or Equivalent (+) : Red (-) : Black
- ◆马达保护 (Motor Protection) : Reverse Polarity Protected; Automatic Restart
- ◆工作温度和湿度 (Operating Temperature and Humidity) : -10°C~70°C, 5%~90%RH
- ◆储存温度和湿度 (Storage Temperature and Humidity) : -40°C~80°C, 5%~95%RH

风扇性能曲线 (Fan Performance Curve)

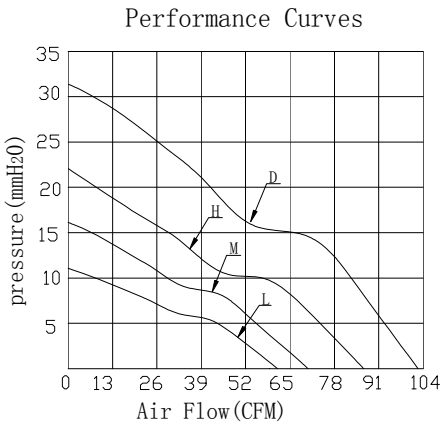

尺寸 (Dimensions) (Unit:mm)

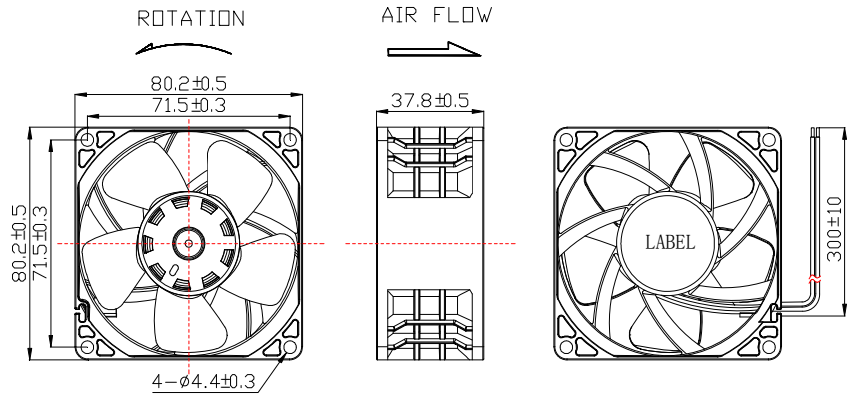

规格 (Specifications)

型号 Listed Model	额定电压 Rated Voltage	工作电压 Operating Voltage	额定电流 Rated Current	转速 Rated Speed	风量 Air Flow	风压 Static pressure	噪音 Noise Level	可选功能 Available Features (Optional)				重量 Weight
	(VDC)	(VDC)	(A)	(RPM)	(CFM)	(mmH2O)	(dBA)	转速侦测 Tachometer Output	锁机报警 Rotation Detector	温控 Thermal Control	脉冲调速 Pulse Width Modulation	g
DFX803812D	12	6.0~13.8	2.00	9,500	103.80	33.80	61.40	◆	◆	◆	◆	143
DFX803812H		6.0~13.8	1.60	8,000	87.40	23.90	57.10	◆	◆	◆	◆	
DFX803812M		6.0~13.8	0.85	6,500	71.40	15.80	50.90	◆	◆	◆	◆	
DFX803812L		6.0~13.8	0.45	5,500	60.10	11.30	45.90	◆	◆	◆	◆	
DFX803824D	24	12.0~27.6	1.40	9,500	103.80	33.80	61.40	◆	◆	◆	◆	
DFX803824H		12.0~27.6	0.80	8,000	87.40	23.90	57.10	◆	◆	◆	◆	
DFX803824M		12.0~27.6	0.45	6,500	71.40	15.80	50.90	◆	◆	◆	◆	
DFX803824L		12.0~27.6	0.25	5,500	60.10	11.30	45.90	◆	◆	◆	◆	
DFX803848D	48	28.0~56.0	0.75	9,500	103.80	33.80	61.40	◆	◆	◆	◆	
DFX803848H		28.0~56.0	0.45	8,000	87.40	23.90	57.10	◆	◆	◆	◆	
DFX803848M		28.0~56.0	0.30	6,500	71.40	15.80	50.90	◆	◆	◆	◆	
DFX803848L		28.0~56.0	0.20	5,500	60.10	11.30	45.90	◆	◆	◆	◆	

X=S:Sleeve Bearing or B: Ball Bearing or H:Hydro Bearing ; Specifications are subject to change without notice

